

Compact Manifold Regulator

ARM5 Series

Width **14 mm**

The One-touch fitting size can be changed.



14 mm

Actual size

2 mounting types are available.

- Direct mount
- DIN rail mount

Backflow function is equipped as a standard.

Common supply and individual supply. Mixed mounting of different fittings is possible (Compatible with Simple Specials).

OUT side

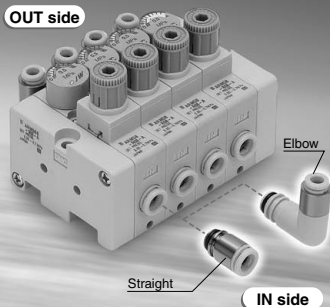

IN side

Single Unit / Individual Supply Type

Port location	Fitting type	Applicable tubing O.D.					
		Metric		Inch			
		4	6	8	5/32	1/4	5/16
IN side	Straight / Elbow	○	○	—	○	○	—
OUT side	Straight / Elbow	○	○	—	○	○	—

Centralized Supply Type

Port location	Fitting type	Applicable tubing O.D.					
		Metric		Inch			
		4	6	8	5/32	1/4	5/16
IN side	Straight / Elbow	—	○	○	—	○	○
OUT side	Straight / Elbow	○	○	—	○	○	—

Manifold

Centralized supply type

Individual supply type

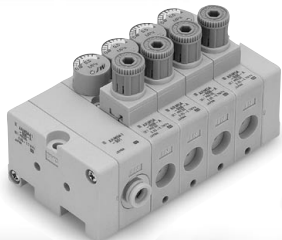

(Direct mount)

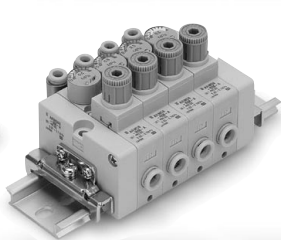

(DIN rail mount)

Single Unit

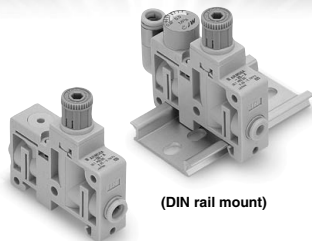

(DIN rail mount)

(Direct mount)

Compact Manifold Regulator Centralized Supply Type **ARM5A Series**

How to Order

ARM5 A A 1 - 4 07 - A

Centralized supply type • ① ② ③ ④ ⑤ ⑥ ⑦

1. Manifold Mounting

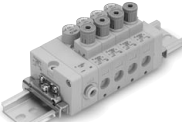
Symbol	A	B
How to mount	Direct mount	DIN rail mount
Appearance		

2. Centralized Supply (IN) Piping Position

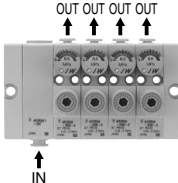
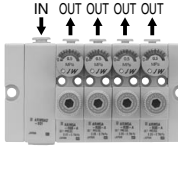
Symbol	1	2
Piping position	Bottom	Top
Appearance		

3. Regulator Block Stations

Symbol	Stations
1	1 station
2	2 stations
3	3 stations
4	4 stations
5	5 stations
6	6 stations
7	7 stations
8	8 stations
9	9 stations
M	10 stations

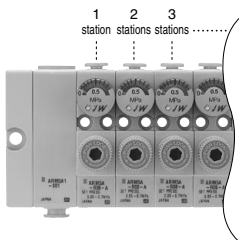

4. IN/OUT Fitting Type (Refer to the figure below.)

Metric size

Mounting position	IN side		OUT side	
	Fitting type	Symbol	Fitting type	Symbol
07	•	ø6	•	ø4
08	•	ø8	•	ø6
09		•	•	ø4
10		•	•	ø6
19		•		•
20		•		•
21		•		•
22		•		•
26	•	ø6	•	ø4
27	•	ø8	•	ø6
28		•	•	ø4
29		•	•	ø6
33		•	•	ø4
34		•	•	ø6
35		•	•	ø4
36		•	•	ø6

Inch size

Mounting position	IN side		OUT side	
	Fitting type	Symbol	Fitting type	Symbol
57	•	ø1/4	•	ø1/4
58	•	ø5/16	•	ø5/32
59		•	•	ø1/4
60		•	•	ø5/32
69		•		•
70		•		•
71		•		•
72		•		•
76	•	ø1/4	•	ø1/4
77	•	ø5/16	•	ø5/32
78		•	•	ø1/4
79		•	•	ø5/32
83		•	•	ø1/4
84		•	•	ø5/32
85		•	•	ø1/4
86		•	•	ø5/32

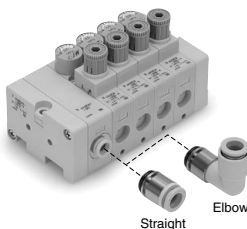



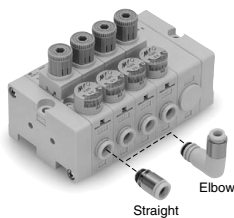

IN side



OUT side (Back side)

Compact Manifold Regulator Centralized Supply Type **ARM5A Series**

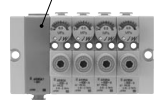
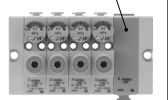
5. Accessories

Symbol	Pressure gauge ^{Note)}		Centralized supply block mounting position		
	Yes	None	L side (Left)	R side (Right)	B side (Both)
					
A	●		●		
B	●			●	
C	●				
D		●	●		●
E		●		●	
F		●			●

Note) Pressure gauges are not compatible with copper-free and fluorine-free specifications.

6. Semi-standard

Symbol	None	0.35 MPa setting ^{Note)}	Non-relieving
Nil	●		
1		●	
2			●
3		●	●

Note) A pressure gauge with a full span of 0.8 MPa is attached.

7. Unit Representation

Symbol	Description
Nil	Display unit for product name plate and pressure gauge: MPa
Z ^{Note)}	Display unit for product name plate and pressure gauge: psi

Note) This option is available for use outside Japan only.
(The SI units must be used in Japan.)

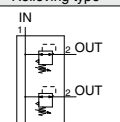
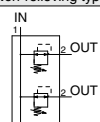
Symbol	
Relieving type	Non-relieving type
	

Note) A standard model is equipped with a backflow function. A main valve opens when the inlet pressure is released, and then an outlet pressure backflows into the inlet side.

Standard Specifications

Model		ARM5A
Regulator construction		Direct acting
Working principle		Piston type
Relief mechanism	Standard	Relieving type
	Semi-standard	Non-relieving type
Backflow function		Within (Unbalanced type)
IN side tubing O.D.		ø6, ø8, ø1/4", ø5/16"
OUT side tubing O.D.		ø4, ø6, ø5/32", ø1/4"
Proof pressure		1.5 MPa
Maximum operating pressure		1.0 MPa
Set pressure range	Standard	0.05 to 0.7 MPa
	Semi-standard	0.05 to 0.35 MPa (Low pressure type)
Fluid		Air
Ambient and fluid temperature		5 to 60°C

Note) 0.1 MPa or greater set pressure is required when used in the reverse flow.

ARM5A Series

Flow Rate Characteristics (Representative Value)

ARM5AA1-307 (One-touch fittings: IN ϕ 6, OUT ϕ 4) Condition: Inlet pressure 0.7 MPa

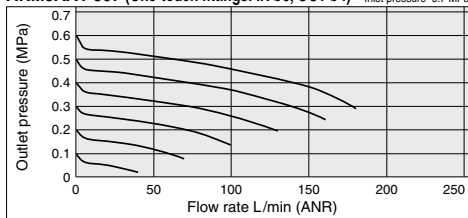

ARM5AA1-307-1 (One-touch fittings: IN ϕ 6, OUT ϕ 4) Condition: Inlet pressure 0.5 MPa

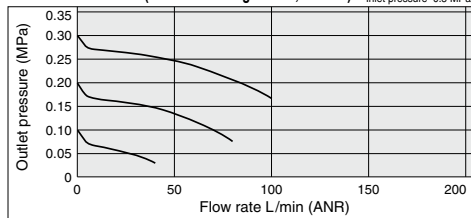

ARM5AA1-308 (One-touch fittings: IN/OUT ϕ 6) Condition: Inlet pressure 0.7 MPa

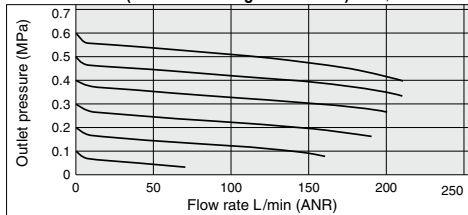

ARM5AA1-308-1 (One-touch fittings: IN/OUT ϕ 6) Condition: Inlet pressure 0.5 MPa

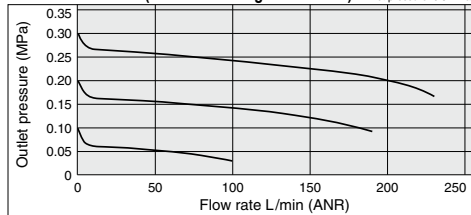

ARM5AA1-309 (One-touch fittings: IN ϕ 8, OUT ϕ 4) Condition: Inlet pressure 0.7 MPa

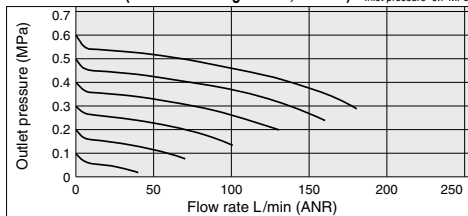

ARM5AA1-309-1 (One-touch fittings: IN ϕ 8, OUT ϕ 4) Condition: Inlet pressure 0.5 MPa

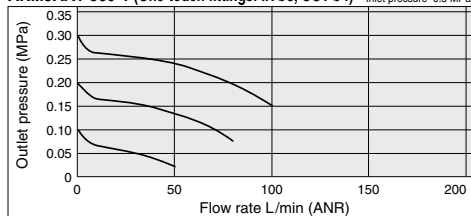

ARM5AA1-310 (One-touch fittings: IN ϕ 8, OUT ϕ 6) Condition: Inlet pressure 0.7 MPa

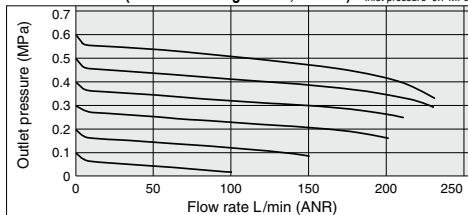

ARM5AA1-310-1 (One-touch fittings: IN ϕ 8, OUT ϕ 6) Condition: Inlet pressure 0.5 MPa

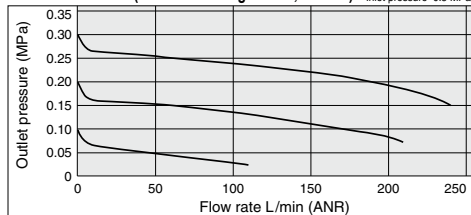

Pressure Characteristics (Representative Value)

ARM5AA1-308 Condition: Inlet pressure 0.7 MPa Outlet pressure 0.2 MPa Flow rate 20 L/min (ANR)

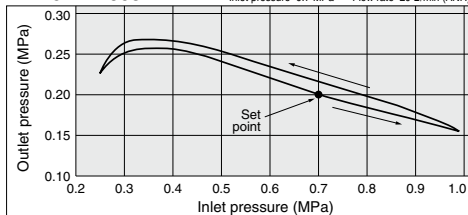

ARM5AA1-308-1 Condition: Inlet pressure 0.5 MPa Outlet pressure 0.2 MPa Flow rate 20 L/min (ANR)

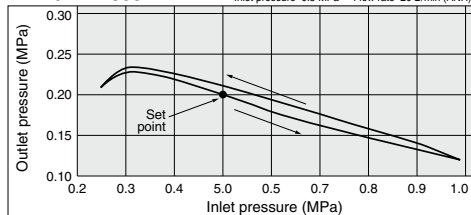

Construction (Centralized Supply Type Regulator Block)

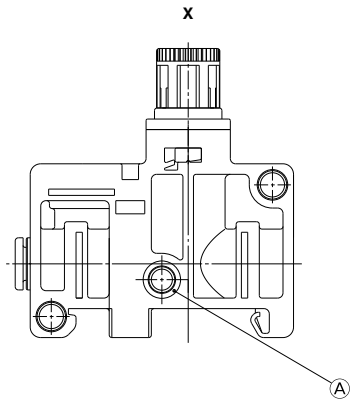
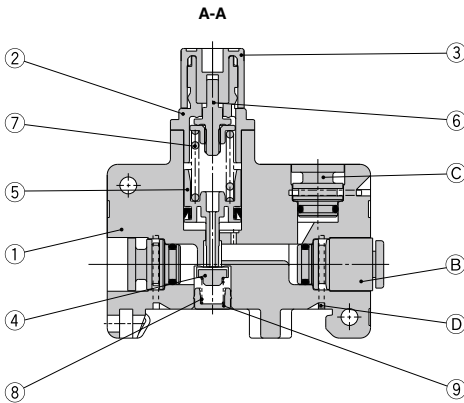
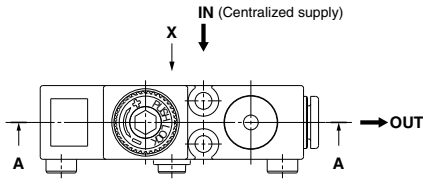

Component Parts

No.	Description	Material
1	Body (for centralized supply)	PBT
2	Bonnet	PBT
3	Knob	POM
4	Valve	HNBR, Aluminum alloy
5	Piston assembly	POM, NBR
6	Adjusting screw assembly	—
7	Adjusting spring	Stainless steel
8	Valve spring	Stainless steel
9	Valve guide	Brass, With electroless nickel plated

Replacement Parts

No.	Description	Material	Qty.	Part no.
A	O-ring	NBR	1	136019
B	Fitting assembly	—	1	Refer to page 704.
C	Port plug	PBT, HNBR	1	Refer to page 705.
D	Clip	Stainless steel	3	136010

ARM5A Series

Dimensions

ARM5AA □ Centralized supply type (Direct mount)

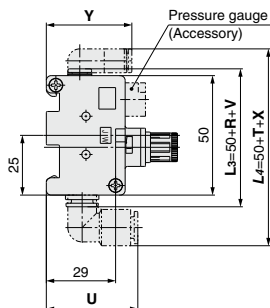

* n = Number of stations for regulator block

For dimensions of One-touch fittings and manifold options, please refer to pages 701 through to 705.

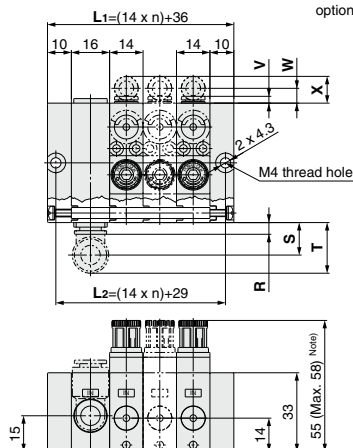

Note) Max. dimension is the size when the knob is unlocked.

Fitting size	IN side				OUT side			
	Straight	Elbow	Elbow	Elbow	Straight	Elbow	Elbow	Elbow
	R	S	T	U	V	W	X	Y
ø4, ø5/32	—	—	—	—	2.5	6	11	35.5
ø6	3	12.5	19	35.5	3	6.5	11	36
ø1/4	3	12.5	19	35.5	6.5	6	11.5	38.5
ø8, ø5/16	5	13.5	21	38.5	—	—	—	—

ARM5AB □ Centralized supply type (DIN rail mount)

* n = Number of stations for regulator block

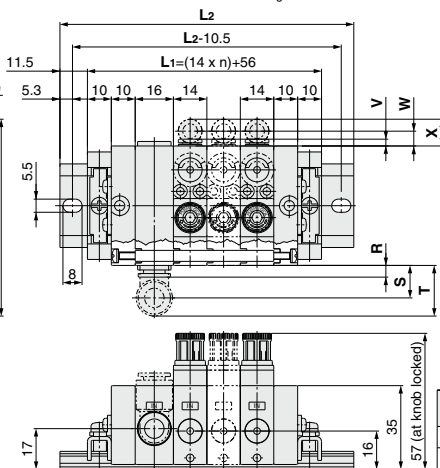
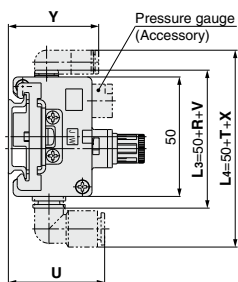

Fitting size	IN side				OUT side			
	Straight	Elbow	Elbow	Elbow	Straight	Elbow	Elbow	Elbow
	R	S	T	U	V	W	X	Y
ø4, ø5/32	—	—	—	—	2.5	6	11	37.5
ø6	3	12.5	19	37.5	3	6.5	11	38
ø1/4	3	12.5	19	37.5	6.5	6	11.5	40.5
ø8, ø5/16	5	13.5	21	40.5	—	—	—	—

Stations	DIN rail part no.	L2 dimension
1	VVQ1000-90-7	98
2	VVQ1000-90-8	110.5
3	VVQ1000-90-9	123
4	VVQ1000-90-11	148
5	VVQ1000-90-12	160.5
6	VVQ1000-90-13	173
7	VVQ1000-90-14	185.5
8	VVQ1000-90-15	198
9	VVQ1000-90-16	210.5
M	VVQ1000-90-17	223



Compact Manifold Regulator Individual Supply Type **ARM5B Series**

How to Order

ARM5 B **A** - 4 07 -

Individual supply type ● ① ② ③ ④ ⑤ ⑥

1. Manifold Mounting

Symbol	A	B
How to mount	Direct mount	DIN rail mount
Appearance		

2. Regulator Block Stations

Symbol	Stations
1	1 station
2	2 stations
3	3 stations
4	4 stations
5	5 stations
6	6 stations
7	7 stations
8	8 stations
9	9 stations
M	10 stations

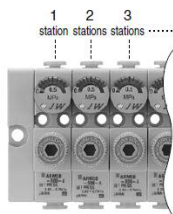

3. IN/OUT Piping Position

Metric size

Mounting position	IN side				OUT side			
	Straight		Elbow		Straight		Elbow	
Symbol	ø4	ø6	ø4	ø6	ø4	ø6	ø4	ø6
06	●				●			
07	●				●			
08	●					●		
18			●				●	
19				●			●	
20								●
25	●						●	
26		●					●	
27		●					●	
32			●		●			●
33				●	●			
34				●		●		

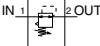
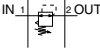
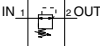
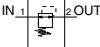

Inch size

Mounting position	IN side				OUT side			
	Straight		Elbow		Straight		Elbow	
Symbol	ø5/32	ø1/4	ø5/32	ø1/4	ø5/32	ø1/4	ø5/32	ø1/4
56	●				●			
57	●				●			
58	●					●		
68			●				●	
69				●			●	
70								●
75	●						●	
76		●					●	
77		●					●	
82			●		●			●
83				●	●			
84				●		●		

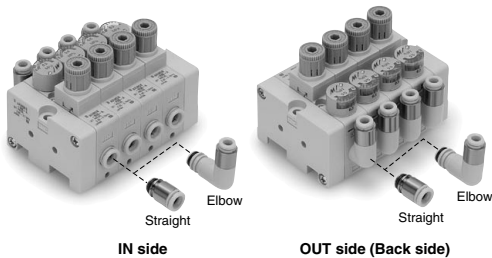
Symbol
Relieving type

Non-relieving type





4. Accessory

Symbol	Pressure gauge ^{Note)}	Configuration
Nll	None	
A	Yes	

Note) Pressure gauges are not compatible with copper-free and fluorine-free specifications.

6. Semi-standard

Symbol	None	0.35 MPa setting ^{Note)}	Non-relieving
Nll	●		
1		●	
2			●
3		●	●

Note) A pressure gauge with a full span of 0.8 MPa is attached.

7. Unit Representation

Symbol	Description
Nll	Display unit for product name plate and pressure gauge: MPa
Z ^{Note)}	Display unit for product name plate and pressure gauge: psi

Note) This option is available for use outside Japan only. (The SI units must be used in Japan.)

Note) A standard model is equipped with a backflow function. A main valve opens when the inlet pressure is released, and then an outlet pressure backflows into the inlet side.

ARM5B Series

Standard Specifications

Model		ARM5B
Regulator construction		Direct acting
Working principle		Piston type
Relief mechanism	Standard	Relieving type
	Semi-standard	Non-relieving type
Backflow function		Within (Unbalanced type)
IN side tubing O.D.		ø4, ø6, ø5/32", ø1/4"
OUT side tubing O.D.		ø4, ø6, ø5/32", ø1/4"
Proof pressure		1.5 MPa
Maximum operating pressure		1.0 MPa
Set pressure range	Standard	0.05 to 0.7 MPa
	Semi-standard	0.05 to 0.35 MPa (Low pressure type)
Fluid		Air
Ambient and fluid temperature		5 to 60°C

Note) 0.1 MPa or greater set pressure is required when used in the reverse flow.

Construction (Individual Supply Type Regulator Block)

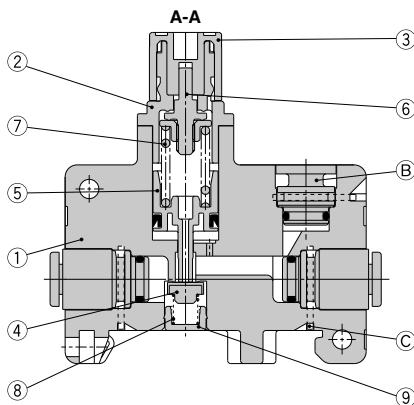
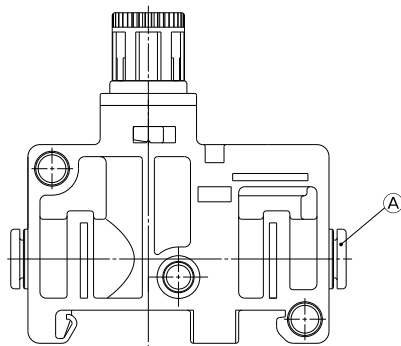
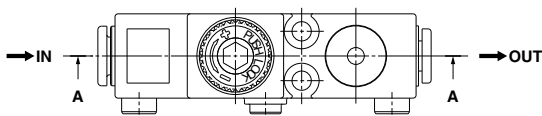

Component Parts

No.	Description	Material
1	Body (for individual supply)	PBT
2	Bonnet	PBT
3	Knob	POM
4	Valve	HNBR, Aluminum alloy
5	Piston assembly	POM, NBR
6	Adjusting screw assembly	—
7	Adjusting spring	Stainless steel
8	Valve spring	Stainless steel
9	Valve guide	Brass, With electroless nickel plated

Replacement Parts

No.	Description	Material	Qty.	Part no.
A	Fitting assembly	—	2	Refer to page 704.
B	Port plug	PBT, HNBR	1	Refer to page 705.
C	Clip	Stainless steel	3	136010

Flow Rate Characteristics (Representative Value)

ARM5BA-306 (One-touch fittings: IN/OUT $\phi 4$) Condition: Inlet pressure 0.7 MPa

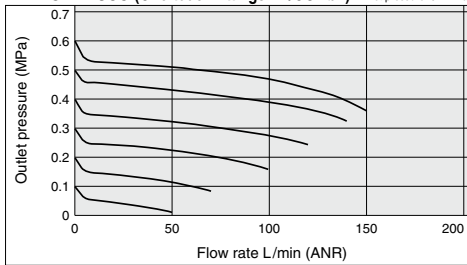

ARM5BA-306-1 (One-touch fittings: IN/OUT $\phi 4$) Condition: Inlet pressure 0.5 MPa

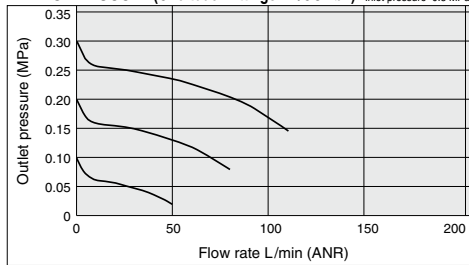

ARM5BA-307 (One-touch fittings: IN $\phi 6$, OUT $\phi 4$) Condition: Inlet pressure 0.7 MPa

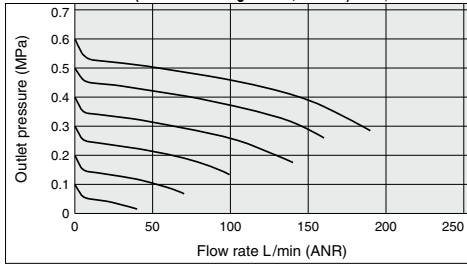

ARM5BA-307-1 (One-touch fittings: IN $\phi 6$, OUT $\phi 4$) Condition: Inlet pressure 0.5 MPa

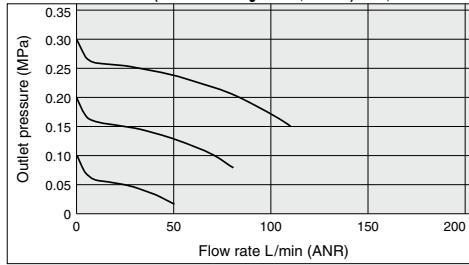

ARM5BA-308 (One-touch fittings: IN/OUT $\phi 6$) Condition: Inlet pressure 0.7 MPa

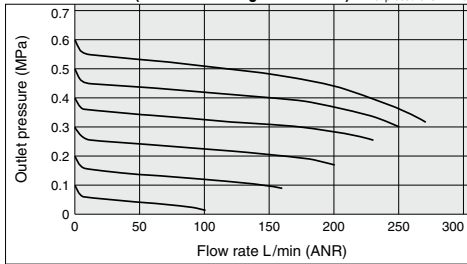

ARM5BA-308-1 (One-touch fittings: IN/OUT $\phi 6$) Condition: Inlet pressure 0.5 MPa

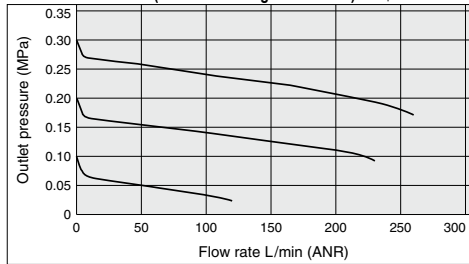

Pressure Characteristics (Representative Value)

ARM5BA-306 Condition: Inlet pressure 0.7 MPa, Outlet pressure 0.2 MPa, Flow rate 20 L/min (ANR)

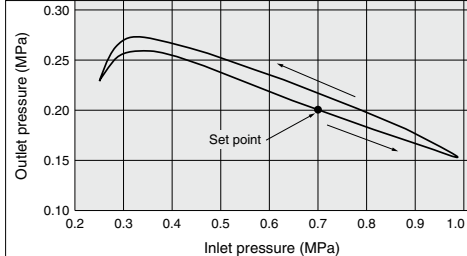

ARM5BA-306-1 Condition: Inlet pressure 0.5 MPa, Outlet pressure 0.2 MPa, Flow rate 20 L/min (ANR)

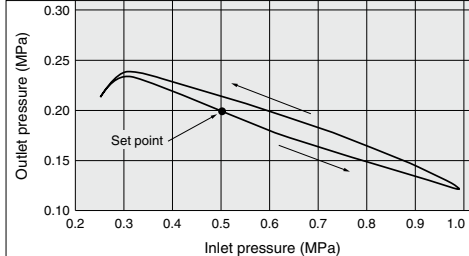

ARM5B Series

Dimensions

ARM5BA Individual supply type (Direct mount)

* n = Number of regulator block stations

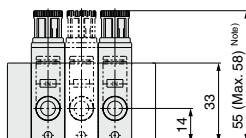
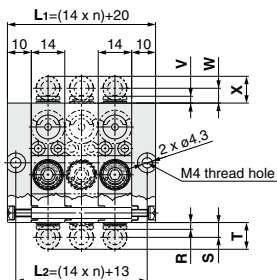
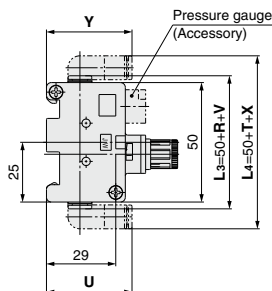

Note) Max. dimension is the size when the knob is unlocked.

Fitting size	IN side				OUT side			
	Straight R	Elbow S	Elbow T	Elbow U	Straight V	Elbow W	Elbow X	Elbow Y
ø4, ø5/32	2.5	6	11	35.5	2.5	6	11	35.5
ø6	3	6.5	11	36	3	6.5	11	36
ø1/4	6.5	6	11.5	38.5	6.5	6	11.5	38.5

ARM5BB Individual supply type (DIN rail mount)

* n = Number of regulator block stations

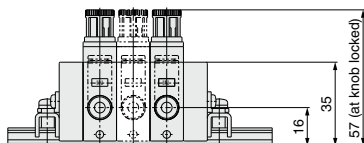
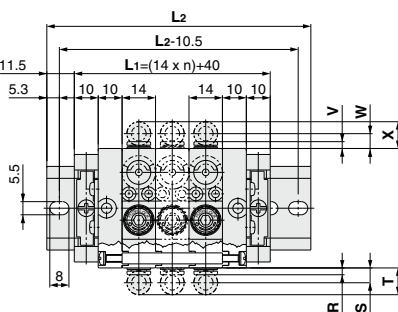
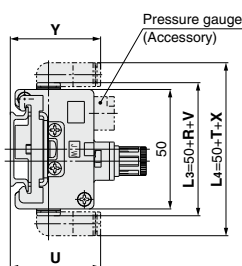

Fitting size	IN side				OUT side			
	Straight R	Elbow S	Elbow T	Elbow U	Straight V	Elbow W	Elbow X	Elbow Y
ø4, ø5/32	2.5	6	11	37.5	2.5	6	11	37.5
ø6	3	6.5	11	38	3	6.5	11	38
ø1/4	6.5	6	11.5	40.5	6.5	6	11.5	40.5

Stations	DIN rail part no.	L2 dimension
1	VVQ1000-90-6	85.5
2	VVQ1000-90-7	98
3	VVQ1000-90-8	110.5
4	VVQ1000-90-9	123
5	VVQ1000-90-10	135.5
6	VVQ1000-90-12	160.5
7	VVQ1000-90-13	173
8	VVQ1000-90-14	185.5
9	VVQ1000-90-15	198
M	VVQ1000-90-16	210.5

Compact Manifold Regulator Options

Centralized Supply Type

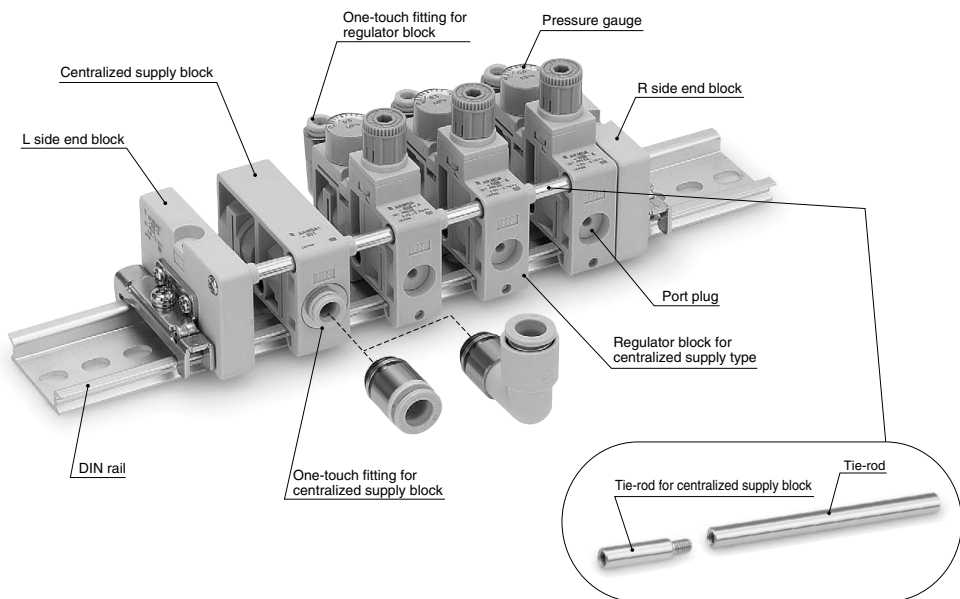

Individual Supply Type

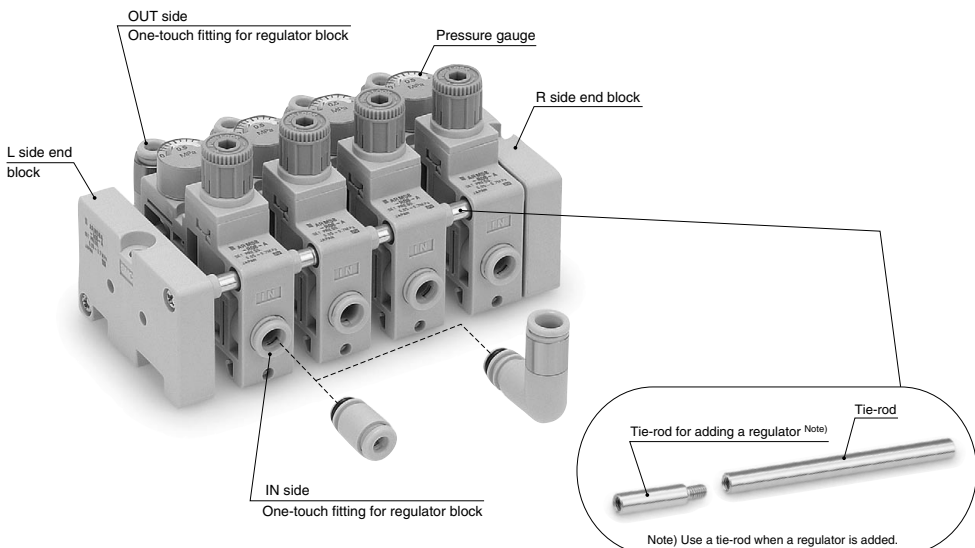

ARM5A/B Series

Regulator Block

Centralized Supply Type ARM5A-R

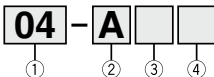

1. OUT Fitting Type

Metric size

Symbol	Straight		Elbow	
	ø4	ø6	ø4	ø6
04	●			
05		●		
16			●	
17				●

Inch size

Symbol	Straight		Elbow	
	ø5/32	ø1/4	ø5/32	ø1/4
54	●			
55		●		
66			●	
67				●

2. Accessories

Symbol	Pressure gauge ^{Note)}		Extension tie-rod	
	Yes	None	Yes	None
A	●			●
B	●			●
C		●	●	
D		●		●

Note) Pressure gauges are not compatible with copper-free and fluorine-free specifications.

3. Semi-standard

Symbol	None	0.35 MPa setting ^{Note)}	Non-relieving
Nil	●		
1		●	
2			●
3		●	●

Note) A pressure gauge with a full span of 0.8 MPa is attached.

4. Unit Representation

Symbol	Description
Nil	Display unit for product name plate and pressure gauge: MPa
Z ^{Note)}	Display unit for product name plate and pressure gauge: psi

Note) This option is available for use outside Japan only. (The SI units must be used in Japan.)

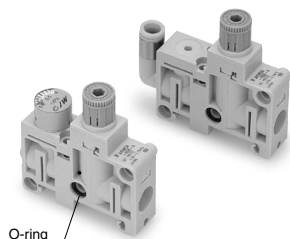

Note) The O-ring is attached to the manifold connection.

Individual Supply Type ARM5B-R

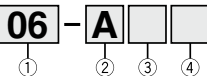

1. IN/OUT Fitting Type

Metric size

Symbol	IN side				OUT side			
	Straight		Elbow		Straight		Elbow	
	ø4	ø6	ø4	ø6	ø4	ø6	ø4	ø6
06	●				●			
07		●			●			
08		●				●		
18			●				●	
19				●			●	
20				●				●
25	●							●
26		●						●
27		●						●
32			●		●			
33				●		●		
34				●			●	

Inch size

Symbol	IN side				OUT side			
	Straight		Elbow		Straight		Elbow	
	ø5/32	ø1/4	ø5/32	ø1/4	ø5/32	ø1/4	ø5/32	ø1/4
56	●				●			
57		●			●			
58		●				●		
68			●				●	
69				●			●	
70				●				●
75	●							●
76		●						●
77		●						●
82			●		●			
83				●		●		
84				●			●	

2. Accessories

Symbol	Pressure gauge ^{Note)}		Extension tie-rod	
	Yes	None	Yes	None
A	●			●
B	●			●
C		●	●	
D		●		●

Note) Pressure gauges are not compatible with copper-free and fluorine-free specifications.

3. Semi-standard

Symbol	None	0.35 MPa setting ^{Note 1)}	Non-relieving
Nil	●		
1		●	
2			●
3		●	●

Note) A pressure gauge with a full span of 0.8 MPa is attached.

4. Unit Representation

Symbol	Description
Nil	Display unit for product name plate and pressure gauge: MPa
Z ^{Note)}	Display unit for product name plate and pressure gauge: psi

Note) This option is available for use outside Japan only. (The SI units must be used in Japan.)

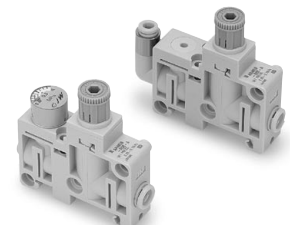

Centralized Supply Block

ARM5A 1 - **S** 01 -

① ② ③

1. Centralized Supply (IN) Piping Position

Symbol	1	2
Piping position	Bottom	Top
Appearance		

2. IN Fitting Type

Symbol	Metric size				Symbol	Inch size			
	IN side		IN side			Straight		Elbow	
	ø6	ø8	ø6	ø8		ø1/4	ø5/16	ø1/4	ø5/16
01	●				51	●			
02		●			52		●		
13			●		63			●	
14				●	64				●

3. Tie-rod for Centralized Supply Block (Note)

Symbol	Description
Nil	Without tie-rod
T	With tie-rod

Note) For details, refer to page 705.

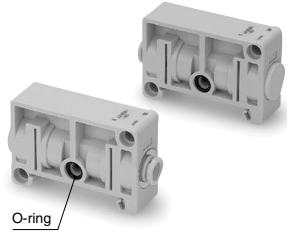
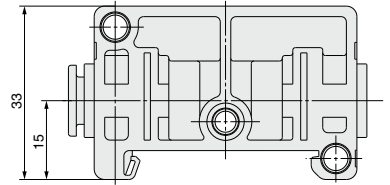
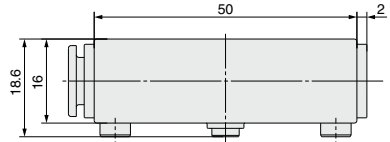

Note) The O-ring is attached to the manifold connection.

End Block

ARM5E A L -

End block ●

● Air supply specification

Symbol	Air supply specification
1	Centralized supply
2	Individual supply

Manifold mounting ●

Symbol	Mounting
A	Direct mount
B	DIN rail mount

Mounting position ●

Symbol	Mounting position
L	Left
R	Right

L side end block

R side end block

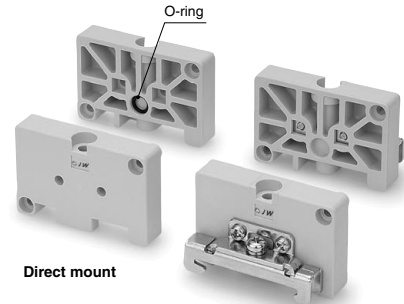

Direct mount

DIN rail mount

L side end block

R side end block

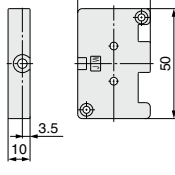
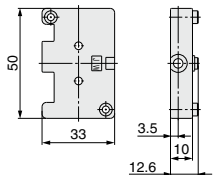

Direct mount

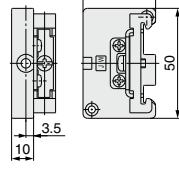
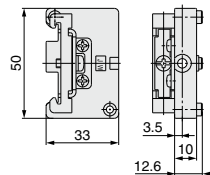

DIN rail mount

ARM5A/B Series

DIN Rail

VVQ1000-90-7

L dimension

Enter the No. for the desired L dimension from the table below.

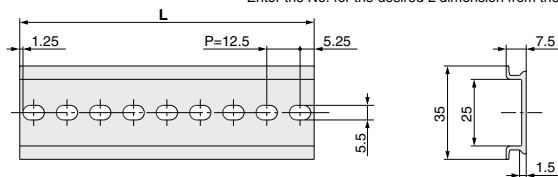

L Dimension

L=12.5 x n + 10.5

No.	1	2	3	4	5	6	7	8	9	10
L dimension	23	35.5	48	60.5	73	85.5	98	110.5	123	135.5
No.	11	12	13	14	15	16	17	18	19	20
L dimension	148	160.5	173	185.5	198	210.5	223	235.5	248	260.5
No.	21	22	23	24	25	26	27	28	29	30
L dimension	273	285.5	298	310.5	323	335.5	348	360.5	373	385.5
No.	31	32	33	34	35	36	37	38	39	40
L dimension	398	410.5	423	435.5	448	460.5	473	485.5	498	510.5

One-touch Fittings for Centralized Supply Block

VVQ1000-51A - C6

One-touch fittings for centralized supply block

Fitting type

Nil	Straight
L1	Elbow

Fitting size

Symbol	Size
C6	ø6
C8	ø8
N7	ø1/4
N9	ø5/16



Straight type

Elbow type

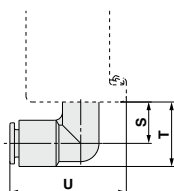
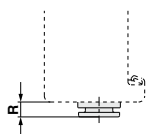

One-touch Fittings for Regulator Block

VVQ1000-50A - C4

One-touch fittings for regulator block

Fitting type

Nil	Straight
L1	Elbow

Fitting size

Symbol	Size
C4	ø4
C6	ø6
N3	ø5/32
N7	ø1/4



Straight type

Elbow type

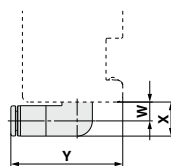
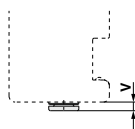

Fitting size	One-touch fittings for centralized supply block			
	Straight	Elbow	Elbow	Elbow
	R	S	T	U
ø4, ø5/32	—	—	—	—
ø6	3	12.5	19	35.5
ø1/4	3	12.5	19	35.5
ø8, ø5/16	5	13.5	21	38.5

Fitting size	One-touch fittings for regulator block			
	Straight	Elbow	Elbow	Elbow
	V	W	X	Y
ø4, ø5/32	2.5	6	11	35.5
ø6	3	6.5	11	36
ø1/4	6.5	6	11.5	38.5
ø8, ø5/16	—	—	—	—

Note) The O-ring is attached.

For details on how to replace, refer to page 713.

Note) The O-ring is attached.

For details on how to replace, refer to page 713.

Pressure Gauge

G14-8-JA

● Indication unit

Symbol	Indication unit	Pressure gauge indication range
NII	MPa	0 to 0.8 MPa
P	psi	0 to 120 psi

Note) The O-ring is attached.
For details on how to replace, refer to page 713.

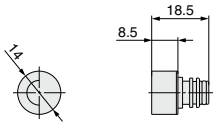

Port Plug

VVQ0000-58A

Single unit regulator /
Port plug for regulator block

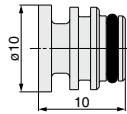

Note) The O-ring is attached.
For details on how to replace, refer to page 713.

Tie-rod

The length of tie-rod will vary corresponding to the number of stations.

● For Regulator Block

Regulator block stations	Tie-rod part no.	Length
1	136016-1A	14
2	136016-2A	28
3	136016-3A	42
4	136016-4A	56
5	136016-5A	70
6	136016-6A	84
7	136016-7A	98
8	136016-8A	112
9	136016-9A	126
10	136016-10A	140

For adding a regulator	Tie-rod part no.	Length
For adding 1 station	136020A	14

Note 1) When adding the regulator block, please use the correct length of tie-rod that corresponds to the number of required stations, or add the extension tie-rod.
Note 2) The part number is for a pair of pieces.

● For Centralized Supply Block

Centralized supply block qty.	Tie-rod part no.	Length
1	136017-1A	16
2	136017-2A	32

Note 1) When adding the centralized air supply block, add the tie-rod for centralized air supply to the regulator block tie-rod. Please pay special attention to its length as this differs from the one for the regulator extension tie-rod.
Note 2) The part number is for a pair of pieces.



Centralized supply block Regulator block

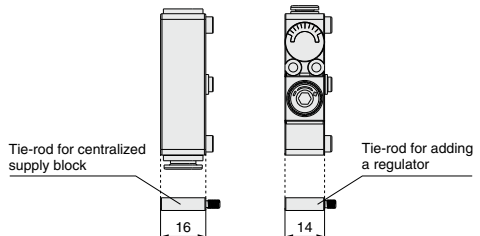
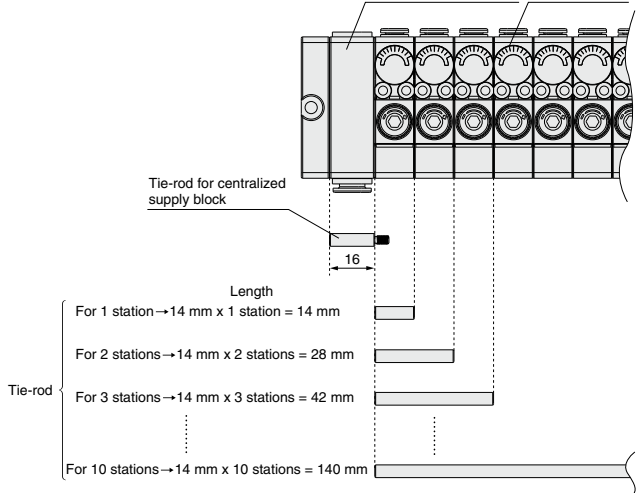

ARM5A/B Series

How to Add Manifold

● In case of the centralized air supply type

It's possible to add the centralized air supply block or regulator block and also alter the position.

Exploded view

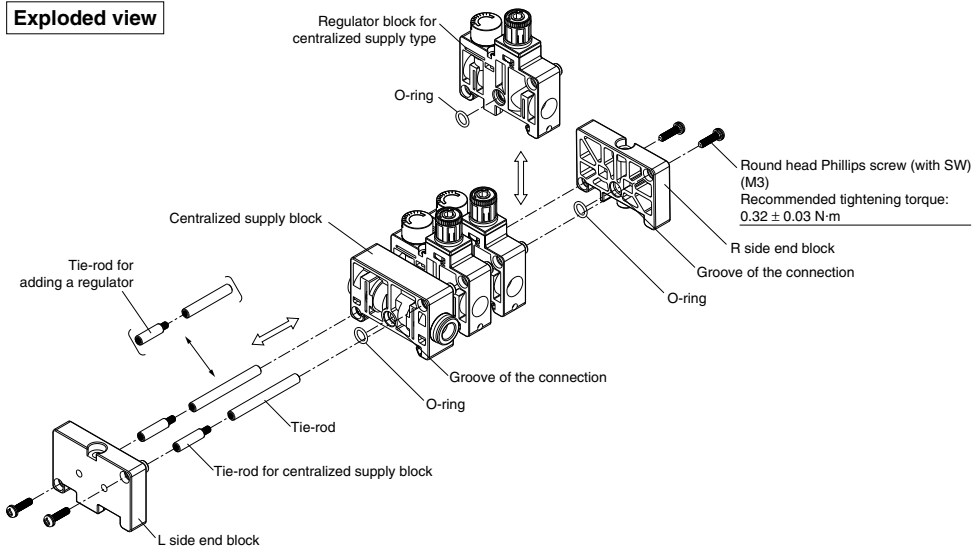

1 Disassembly

- Loosen the 4 round head Phillips screws at the corners of the end block. (Each 2 locations on both the right and left side)
- Remove the tie-rod from the end block, centralized air supply block, and regulator block.

2 Additional parts (Please prepare separately.)

- Centralized supply block, Regulator block
- Tie-rod
Note) A tie-rod, which is corresponding to the regulator block stations, or additional tie-rod for increasing the station will be required.

3 Assembly

- Connect the tie-rods.
- Insert the tie-rod to the end block on the L side, and temporarily tighten the round head Phillips screws. (2 screws)
- Check the O-ring is fitted in the groove of the connection on each manifold block and then insert each block to the tie-rod.
- Temporarily tighten the round head Phillips screws on the R side. (2 screws)
- Additionally tighten the round head Phillips screws on both sides of the manifold with the recommended tightening torque.

⚠ Caution

- Before disassembly, be sure to check that no inlet or outlet pressure is applied and exhaust the internal pressure thoroughly before starting the job.
- After assembly, if the connection between each block, or the tightened tie-rod screws are insufficient, air leakage may occur. Before use, only connect the air after confirming that all the components are securely fixed and that there is no air leakage.

● How to remove DIN rail for DIN rail mount type

Exploded view

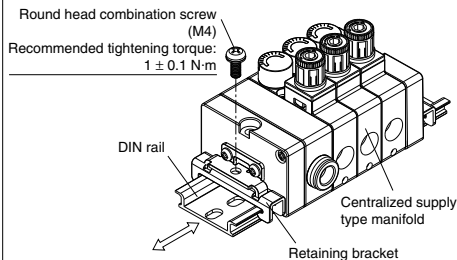

1 Disassembly

- Loosen the round head combination screws. (located on both the right and left side)
- Remove the DIN rail, sliding it horizontally.
- Remove the retaining bracket.

2 Assembly

- Set the retaining bracket to the original position.
- Insert the DIN rail.
- Tighten the round head combination screw with the recommended tightening torque. (located on both the right and left side)

● In case of the Individual air supply type

It's possible to add the regulator block and also alter the position.

Exploded view

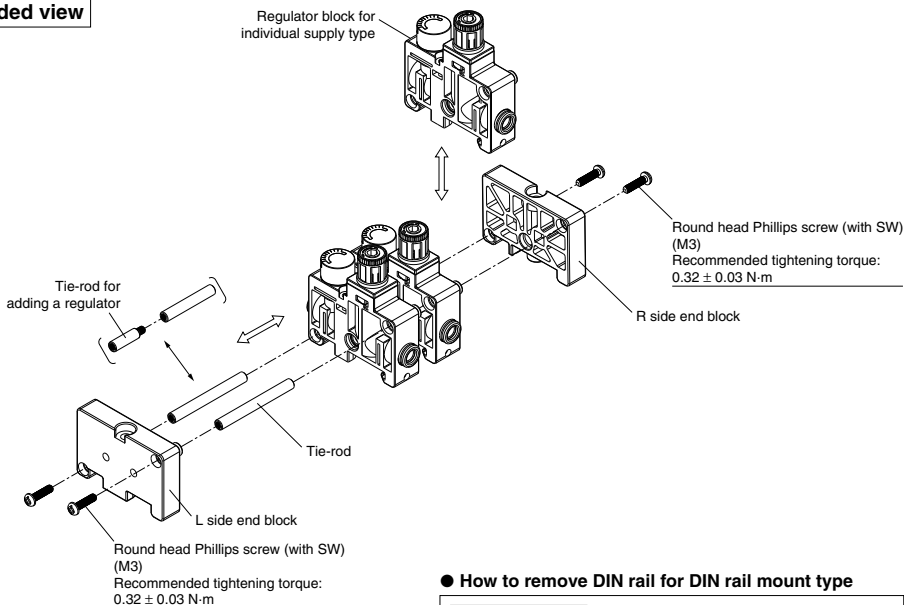

1 Disassembly

- ① Loosen the 4 round head Phillips screws at the corners of the end block. (Each 2 locations on both the right and left side)
- ② Remove the tie-rod from the end block and regulator block.

2 Additional parts (Please prepare separately.)

- ① Regulator block
- ② Tie-rod
Note) A tie-rod, which is corresponding to the regulator block stations, or additional tie-rod for increasing the station will be required.

3 Assembly

- ① Connect the tie-rods.
- ② Insert the tie-rod to the end block on the L side, and temporarily tighten the round head Phillips screws. (2 screws)
- ③ Insert each block to the tie-rod.
- ④ Temporarily tighten the round head Phillips screws on the R side. (2 screws)
- ⑤ Additionally tighten the round head Phillips screws on both sides of the manifold with the recommended tightening torque.

⚠ Caution

- ① Before disassembly, be sure to check that no inlet or outlet pressure is applied and exhaust the internal pressure thoroughly before starting the job.

● How to remove DIN rail for DIN rail mount type

Exploded view

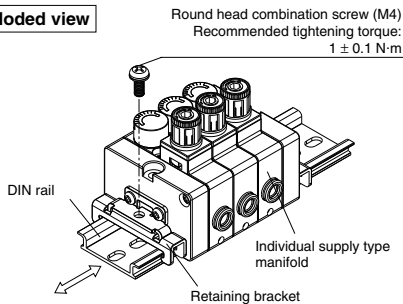

1 Disassembly

- ① Loosen the round head combination screws. (located on both the right and left side)
- ② Remove the DIN rail, sliding it horizontally.
- ③ Remove the retaining bracket.

2 Assembly

- ① Set the retaining bracket to the original position.
- ② Insert the DIN rail.
- ③ Tighten the round head combination screw with the recommended tightening torque. (located on both the right and left side)

Regulator Single Unit Type **ARM5S Series**

How to Order

ARM5 S **A** - **07** -

Single unit type • ① ② ③ ④ ⑤

1. Regulator Mounting

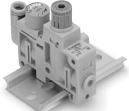
Symbol	A	B
How to mount	Direct mount	DIN rail mount <small>Note</small>
Appearance		

Note) Both the square nut and the hexagon socket head screw are attached for the DIN rail mount type. (DIN rail is not attached.) Refer to the page 712 for handling.

2. IN/OUT Fitting Type

Metric size

Mounting position Fitting type Symbol	IN side				OUT side			
	Straight	Elbow	Straight	Elbow	Straight	Elbow	Straight	Elbow
06	●				●			
07		●			●			
08		●				●		
18			●				●	
19				●			●	
20				●				●
25	●							●
26		●						●
27		●						●
32			●			●		
33				●		●		
34					●			

Inch size

Mounting position Fitting type Symbol	IN side				OUT side			
	Straight	Elbow	Straight	Elbow	Straight	Elbow	Straight	Elbow
56	●				●			
57		●			●			
58		●				●		
68			●				●	
69				●			●	
70				●				●
75	●							●
76		●						●
77		●						●
82			●			●		
83				●		●		
84					●			

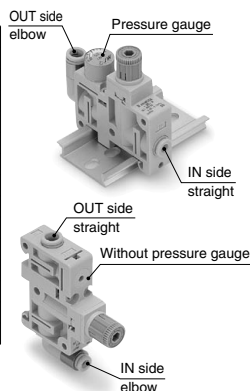

3. Accessory

Symbol	Accessory
Nil	Without pressure gauge
A	With pressure gauge

4. Semi-standard

Symbol	None	0.35 MPa setting <small>Note</small>	Non-relieving
Nil	●		
1		●	
2			●
3			●

Note) A pressure gauge with a full span of 0.8 MPa is attached.

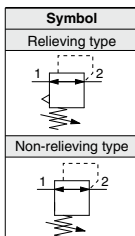

Note) A standard model is equipped with a backflow function. A main valve opens when the inlet pressure is released, and then an outlet pressure backflows into the inlet side.

5. Unit Representation

Symbol	Description
Nil	Display unit for product name plate and pressure gauge: MPa
Z <small>Note</small>	Display unit for product name plate and pressure gauge: psi

Note) This option is available for use outside Japan only. (The SI units must be used in Japan.)

Standard Specifications

Model		ARM5S
Regulator construction		Direct acting
Working principle		Piston type
Relief mechanism	Standard	Relieving type
	Semi-standard	Non-relieving type
Backflow function		Within (Unbalanced type)
IN side tubing O.D.		ø4, ø6, ø5/32", ø1/4"
OUT side tubing O.D.		ø4, ø6, ø5/32", ø1/4"
Proof pressure		1.5 MPa
Maximum operating pressure		1.0 MPa
Set pressure range	Standard	0.05 to 0.7 MPa
	Semi-standard	0.05 to 0.35 MPa (Low pressure type)
Fluid		Air
Ambient and fluid temperature		5 to 60°C
Weight (at ARM5SA-08-A)		33 g

Note) 0.1 MPa or greater set pressure is required when used in the reverse flow.

Flow Rate Characteristics (Representative Value)

ARM5SA-06 (One-touch fittings: IN/OUT $\phi 4$) Condition: Inlet pressure 0.7 MPa

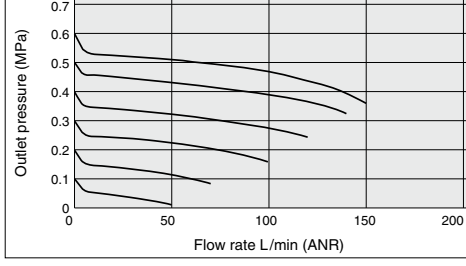

ARM5SA-06-1 (One-touch fittings: IN/OUT $\phi 4$) Condition: Inlet pressure 0.5 MPa

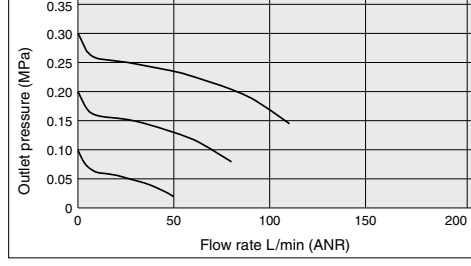

ARM5SA-07 (One-touch fittings: IN $\phi 6$, OUT $\phi 4$) Condition: Inlet pressure 0.7 MPa

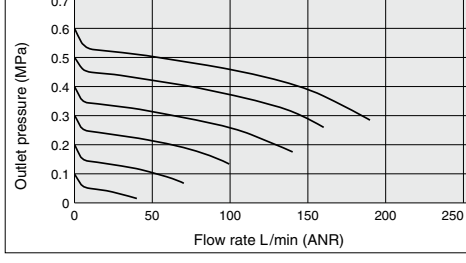

ARM5SA-07-1 (One-touch fittings: IN $\phi 6$, OUT $\phi 4$) Condition: Inlet pressure 0.5 MPa

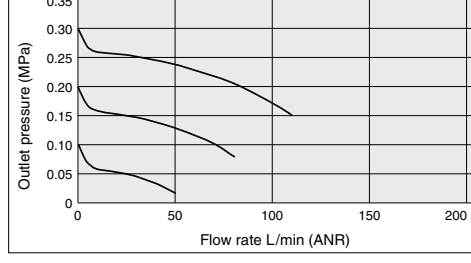

ARM5SA-08 (One-touch fittings: IN/OUT $\phi 6$) Condition: Inlet pressure 0.7 MPa

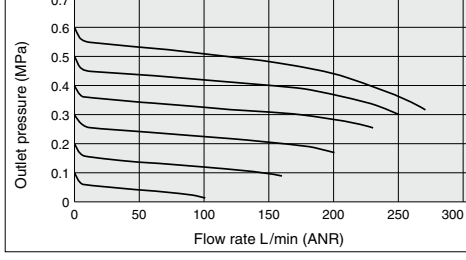

ARM5SA-08-1 (One-touch fittings: IN/OUT $\phi 6$) Condition: Inlet pressure 0.5 MPa

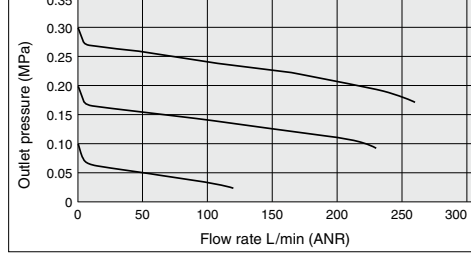

Pressure Characteristics (Representative Value)

ARM5SA-08 Condition: Inlet pressure 0.7 MPa Outlet pressure 0.2 MPa Flow rate 20 L/min (ANR)

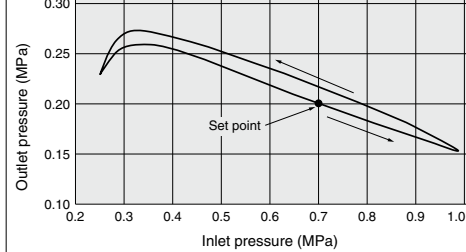

ARM5SA-08-1 Condition: Inlet pressure 0.5 MPa Outlet pressure 0.2 MPa Flow rate 20 L/min (ANR)

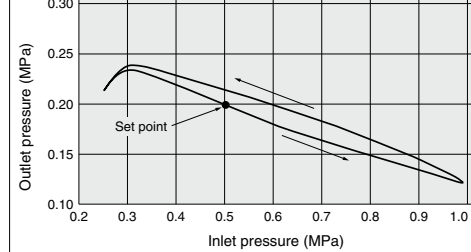

ARM5S Series

Construction (Regulator)

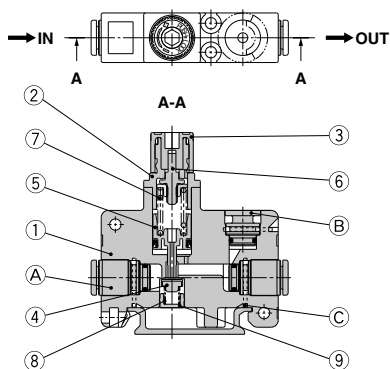

Component Parts

No.	Description	Material
1	Body (for single unit)	PBT
2	Bonnet	PBT
3	Knob	POM
4	Valve	HNBR, Aluminum alloy
5	Piston assembly	POM, NBR
6	Adjusting screw assembly	—
7	Adjusting spring	Stainless steel
8	Valve spring	Stainless steel
9	Valve guide	Brass, With electroless nickel plated
10	Clip	Stainless steel

Replacement Parts

No.	Description	Material	Qty.	Part no.
A	Fitting assembly	—	2	Refer to page 711.
B	Port plug	PBT, HNBR	1	Refer to page 705.
C	Clip	Stainless steel	3	136010

Dimensions

ARM5SA Single unit type (Direct mount)

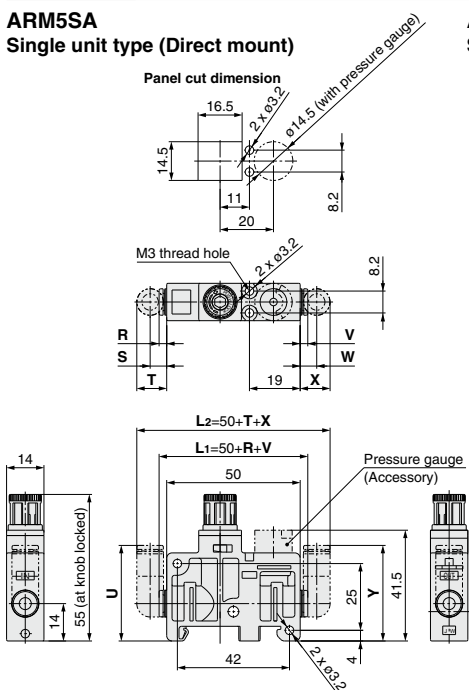

ARM5SB Single unit type (DIN rail mount)

For dimensions of One-touch fittings and accessories, please refer to page 711.

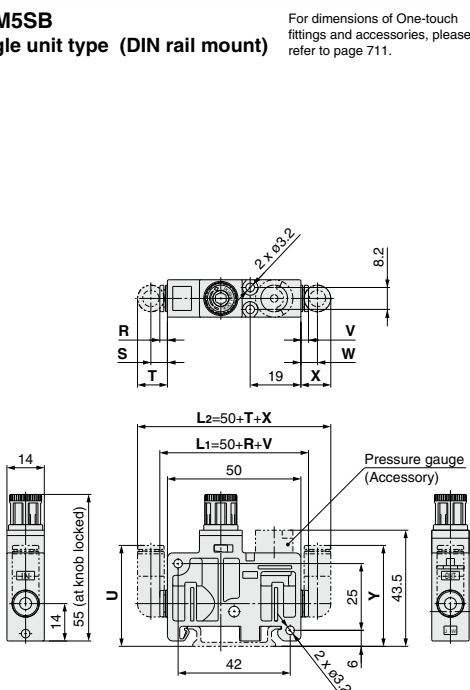

Fitting size	IN side				OUT side			
	Straight	Elbow	Elbow	Elbow	Straight	Elbow	Elbow	Elbow
	R	S	T	U	V	W	X	Y
ø4, ø5/32	2.5	6	11	35.5	2.5	6	11	35.5
ø6	3	6.5	11	36	3	6.5	11	36
ø1/4	6.5	6	11.5	38.5	6.5	6	11.5	38.5

Fitting size	IN side				OUT side			
	Straight	Elbow	Elbow	Elbow	Straight	Elbow	Elbow	Elbow
	R	S	T	U	V	W	X	Y
ø4, ø5/32	2.5	6	11	37.5	2.5	6	11	37.5
ø6	3	6.5	11	38	3	6.5	11	38
ø1/4	6.5	6	11.5	40.5	6.5	6	11.5	40.5

Regulator/Single Unit Type Options

Pressure Gauge

G14-8-JA



Indication unit

Symbol	Indication unit	Pressure gauge indication range
Nil	MPa	0 to 0.8 MPa
P	psi	0 to 120 psi

Note) The O-ring is attached.
For details on how to replace, refer to page 713.

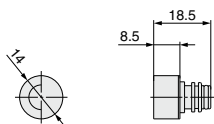

One-touch Fittings for Regulator

VVQ1000-50A-C4

One-touch fittings
for regulator

Fitting type

Nil	Straight
L1	Elbow

Fitting size

C4	ø4
C6	ø6
N3	ø5/32
N7	ø1/4

Straight type

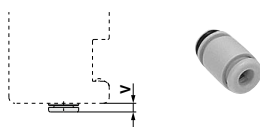

Elbow type

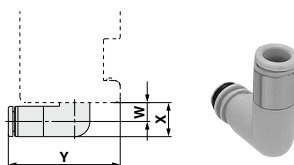

Fitting size	One-touch fittings for regulator			
	Straight	Elbow	Elbow	Elbow
	V	W	X	Y
ø4, ø5/32	2.5	6	11	35.5
ø6	3	6.5	11	36
ø1/4	6.5	6	11.5	38.5
ø8, ø5/16	—	—	—	—

Note) The O-ring is attached.
For details on how to replace, refer to page 713.



ARM5 Series Blocks/Specific Product Precautions 1

Be sure to read this before handling the products. Refer to back page 50 for Safety Instructions and pages 387 to 391 for Precautions on every series.

Handling

Warning

Observe the proper screw tightening torque in installation.

Tightening beyond the proper tightening torque may damage the mounting screws, blocks or switches. If the force is below the tightening torque range, the threaded joint can come loose.

1. Tightening torque for round head Phillips screws for tie-rods of the regulator manifold.

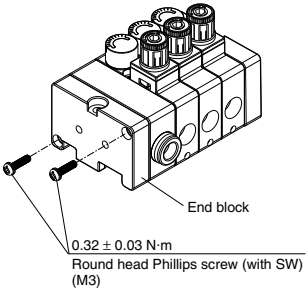

2. Tightening torque for round head combination screws for DIN rail of the regulator manifold

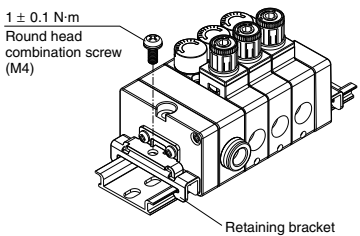

3. Tightening torque for set screws for direct mounting regulator manifold

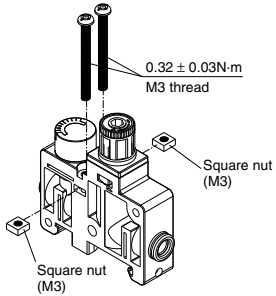

4. Tightening torque for hexagon socket set screws for DIN rail of the regulator manifold

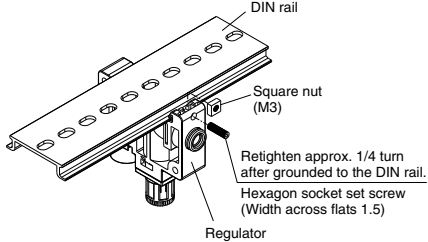

5. There will be slight variations in the width of regulator blocks, centralized supply blocks, and end blocks due to tolerance. For the direct mounting type, there will be an error due to accumulated tolerance between the actual pitch dimensions of the M4 mounting holes and the values stated in the catalog. Keep this in mind when increasing the number of stations.

Be sure to check the pitch dimensions of the M4 mounting holes on the actual product or change the mounting hole on the mounting side to a long hole as shown in the diagram below.

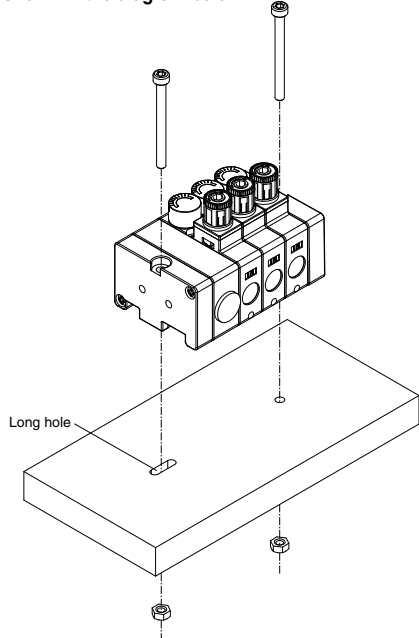

Note) M3 threads and square nuts are not included.



ARM5 Series Blocks/Specific Product Precautions 2

Be sure to read this before handling the products. Refer to back page 50 for Safety Instructions and pages 387 to 391 for Precautions on every series.

Handling

Caution

One-touch fitting replacement

For the ease of replacement, One-touch fittings are installed as the cassette type. One-touch fittings are retained with clips inserted from the directions illustrated below. Remove the clips with a flat head screw driver to replace the One-touch fittings. When installing, insert each One-touch fitting deeply to the end and reinsert the clip to the specified position.

1. Regulator block

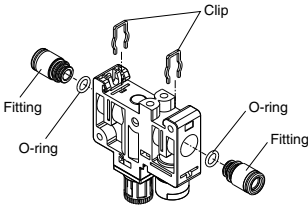

2. Centralized supply block

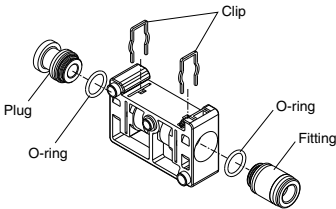

Note 1) Before replacing, be sure to confirm that no inlet or outlet pressure is applied and that the internal pressure is fully exhausted. Replacing with the pressure kept inside is dangerous.

Note 2) Gently remove the clip by hand. Pulling forcibly may cause the clip to pop out, resulting in dangerous replacement.

Note 3) When removing the straight type One-touch fitting from each block, remove the clip, connect a tube or plug (KQ2P-□□) with the One-touch fitting, and pull out by supporting the tube (or plug). The bushing may be damaged, if released by supporting the release bushing of the One-touch fitting.

Note 4) Insert the clip thoroughly after replacement parts are inserted completely. If using with the clip inserted insufficiently, it may cause the clip to be released, resulting in dangerous operation.

Note 5) When inserting a tube into the elbow type One-touch fitting, hold the fitting body in your hand and insert the tube. If the tube is inserted without support, an unreasonable force may be applied on the blocks or One-touch fittings, resulting in air leakage or product failure.

Pressure gauge and port plug replacement

Possible to replace the pressure gauge and port plug the same as the One-touch fitting replacement.

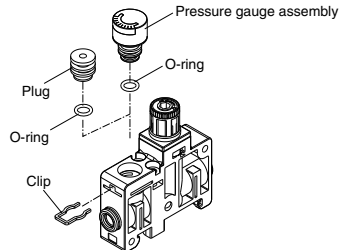

Note 1) Before replacing, be sure to confirm that no inlet or outlet pressure is applied and that the internal pressure is fully exhausted. Replacing with the pressure kept inside is dangerous.

Note 2) Gently remove the clip by hand. Pulling forcibly may cause the clip to pop out, resulting in dangerous replacement.

Note 3) Lightly screw a M3 screw, etc. in the port plug hole and pull it to remove the port plug.

Note 4) Insert the clip thoroughly after replacement parts are inserted completely. If using with the clip inserted insufficiently, it may cause the clip to be released, resulting in dangerous operation.



ARM5 Series Blocks/Specific Product Precautions 3

Be sure to read this before handling the products. Refer to back page 50 for Safety Instructions and pages 387 to 391 for Precautions on every series.

Adjustment

Warning

Regulators

1. Set the regulator while confirming the inlet pressure and the outlet pressure displayed on the pressure gauge. Rotating the knob excessively may damage internal parts.
2. Rotate the pressure adjustment knob only after unlocking. If rotated while locked, the connecting part between the body and the bonnet may be damaged.
3. For pressure adjustment knob operation, a hexagon wrench can be used in the direction of the pressure increase. If it is used in the direction of pressure decrease, the knob may be damaged. Operate the knob manually.

Caution

Regulators

1. Set the regulator while carefully confirming the inlet pressure.
2. The outlet pressure range must be 85% or less than the inlet pressure. However, it must be within the set pressure range.
3. Release the lock to adjust the pressure. After the adjustment, engage the lock. Failure to observe this procedure could damage the knob or cause the outlet pressure to fluctuate.
4. Turn the pressure adjustment knob clockwise to increase the outlet pressure and counterclockwise to decrease the pressure. (To set the pressure, do so in the direction of pressure increase.)

Pressure gauge and One-touch fittings

1. Both the pressure gauge and the One-touch fittings are a cassette type, so that it is possible to rotate them freely.
Rotate them after confirming that there is no pressure inside and exhausting air completely.